

PUERTA DE EMERGENCIA CON RESISTENCIA AL FUEGO DE 2-3 HORAS SEGUN NORMA

CERTIFICADAS



DETALLE PUERTA DE EMERGENCIA

MULTIDISCIPLINAS
 TELEFONO: (506) 2222-0908
 E-MAIL: mcercone@multi.cr



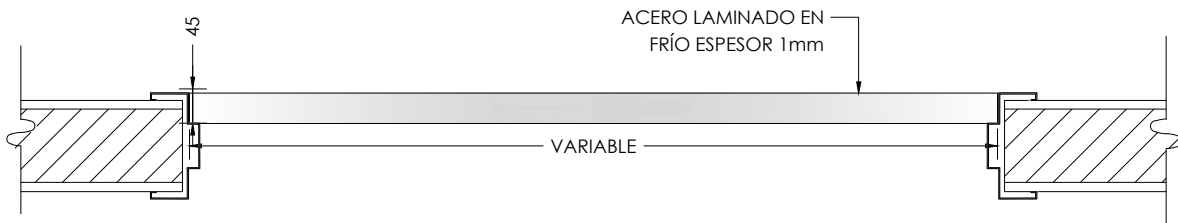

CARA SUPERIOR

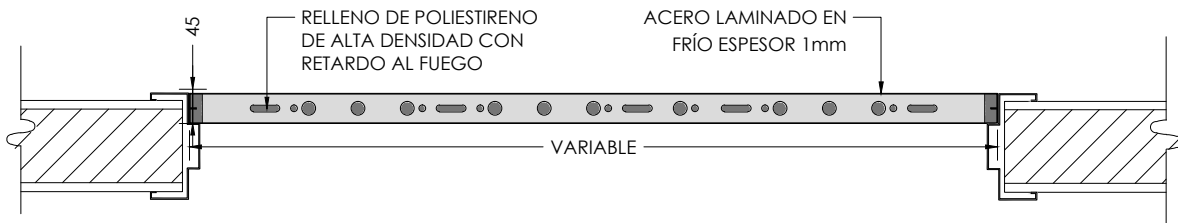

CARA INFERIOR

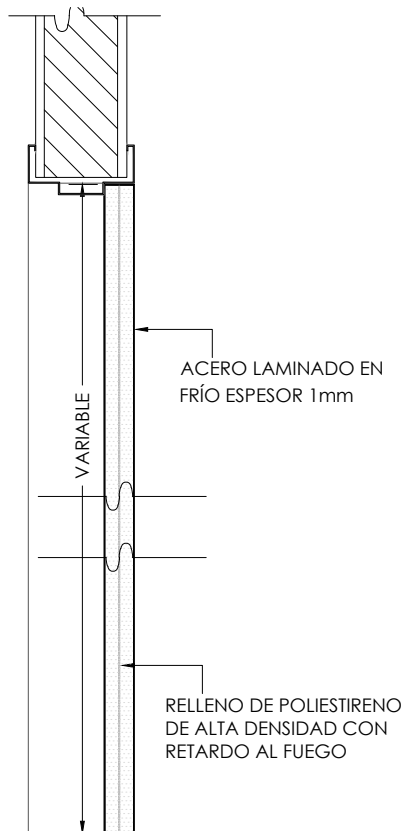

CORTE A-A

CERTIFICADAS



DETALLE PUERTA DE EMERGENCIA

MULTIDISCIPLINAS
 TELEFONO: (506) 2222-0908
 E-MAIL: mcercone@multi.cr



UNIÓN DE MARCOS

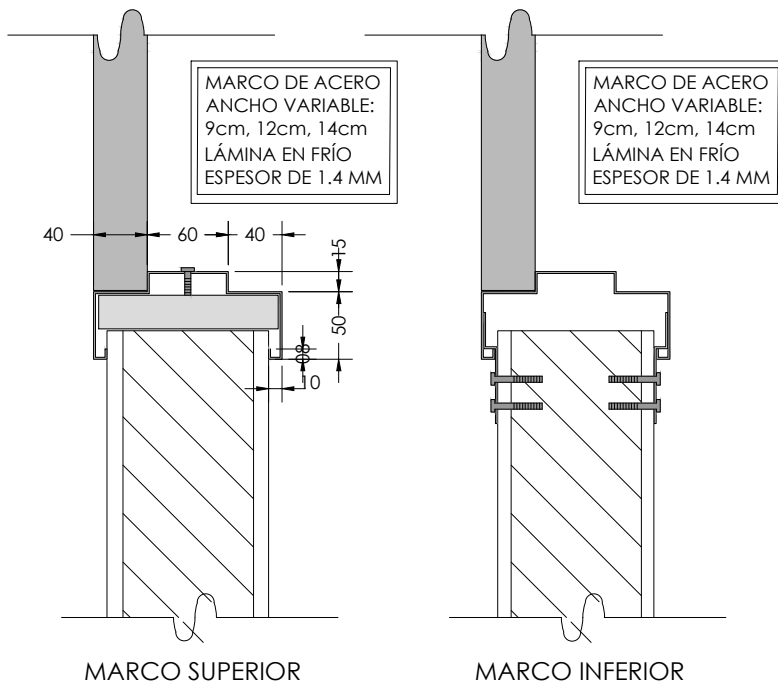

ANCLAJE EN BUQUE TIPO 1

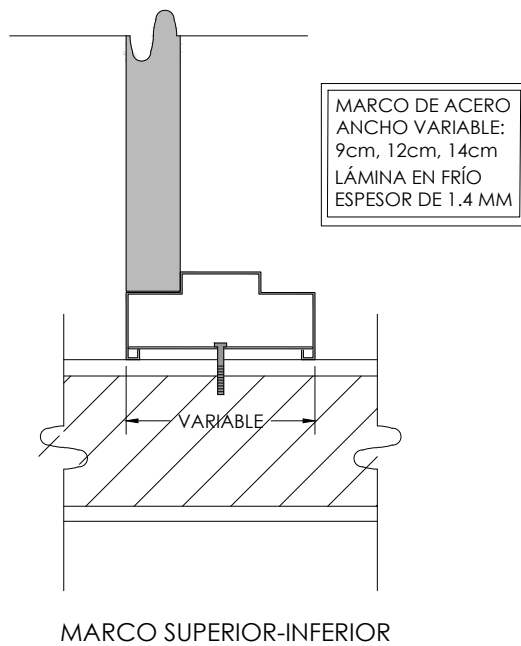

ANCLAJE DE BUQUE DE TIPO 2

1



2



3



CERTIFICADAS



DETALLE PUERTA DE EMERGENCIA

MULTIDISCIPLINAS
TELEFONO: (506) 2222-0908
E-MAIL: mcercone@multi.cr



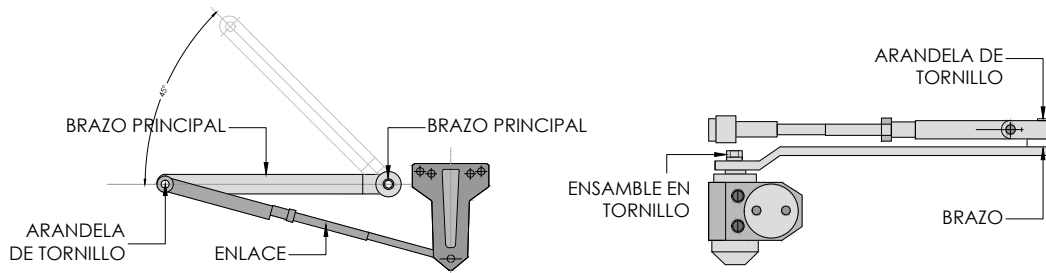

BRAZO PARA PUERTA

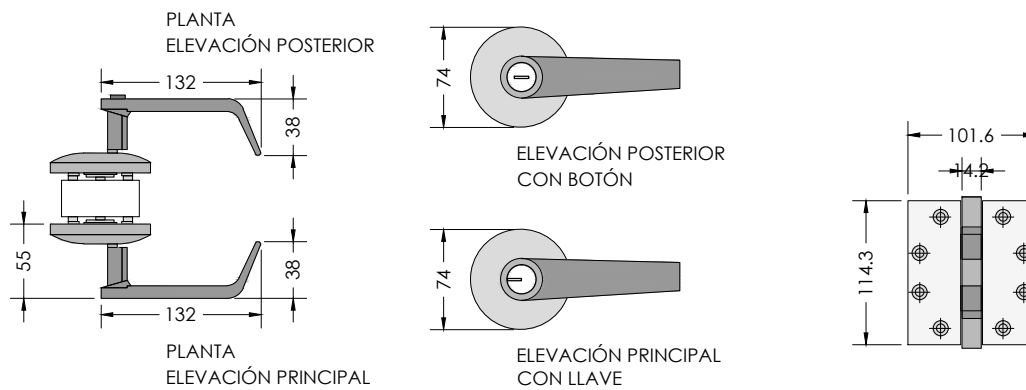

MANIJA
 ACERO INOXIDABLE 304
 ESPESOR DE PUERTA: 45-50mm
 CERTIFICADO: EN 1634 CON
 RESISTENCIA AL FUEGO

BISAGRA
 ESPESOR DE PUERTA 45-50 mm
 TAMAÑO DE BISAGRA 4"4
 SOPORTA UN PESO DE 55-80 KG
 SE NECESITAN 3 BISAGRA POR PUERTA

CERTIFICADAS



DETALLE PUERTA DE EMERGENCIA

MULTIDISCIPLINAS
 TELEFONO: (506) 2222-0908
 E-MAIL: mcercone@multi.cr

